

RoHS HF 469 Series – 1206 Slo-Blo® Fuse

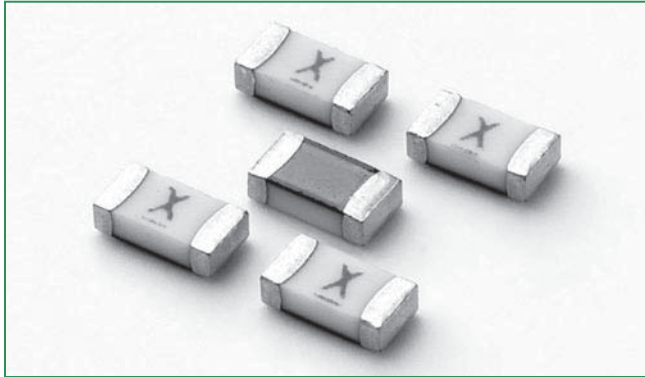

Description

The 469 Series is a 100% Lead-free, RoHS compliant and Halogen-free fuse series designed specifically to provide over-current protection to circuits that operate under high working ambient temperature up to 150°C.

The general design ensures excellent temperature stability and performance reliability.

The high I²t values which are typical in the Littelfuse Ceramic fuse family, ensure high inrush current withstand capability.



Features

- Operating Temperature from -55°C to +150°C
- Suitable for both leaded and lead-free reflow / wave soldering
- 100% Lead-free, RoHS compliant and Halogen-free

Applications

- Automotive Electronics
- LCD Displays
- Servers
- Notebook Computers
- Printers
- Scanners
- Data Modems
- Gaming Consoles



Agency Approvals

AGENCY	AGENCY FILE NUMBER	AMPERE RANGE
	E10480	1A – 8A
	LR29862 (Pending)	1A – 8A

Electrical Characteristics for Series

% of Ampere Rating	Ampere Rating	Opening Time at 25°C
100%	1A – 8A	4 hours, Minimum
200%	1A – 8A	1 sec., Min.; 120 secs., Max.
300%	1A – 8A	0.1 sec., Min.; 3 secs., Max.
800%	1A – 8A	0.002 sec., Min.; 0.05 sec., Max.

Electrical Specifications by Item

Ampere Rating (A)	Amp Code	Max. Voltage Rating (V)	Interrupting Rating	Nominal Resistance (Ohms) ²	Nominal Melting I ² t (A ² Sec.) ³	Nominal Voltage Drop At Rated Current (V) ⁴	Nominal Power Dissipation At Rated Current (W)	Agency Approvals									
																	
1	001.	63	50 A @ 63 V DC	0.052	3.560	0.236	0.944	pending	pending								
1.25	1.25	63						pending	pending								
1.5	01.5	63						x	pending								
2	002.	63						x	pending								
2.5	02.5	32	50 A @ 32 V DC					0.035	5.620	0.216	1.080	x	pending				
3	003.	32										x	pending				
3.5	03.5	32										x	pending				
4	004.	32										x	pending				
5	005.	32	60 A @ 32 V DC									0.028	9.410	0.274	1.640	x	pending
6	006.	24														x	pending
7	007.	24		x	pending												
8	008.	24		x	pending												
			60 A @ 24 V DC	0.021	14.400	0.216	1.510									x	pending
																x	pending
								x	pending								
								x	pending								
								0.017	23.720	0.233	1.860					x	pending

Notes:

1. AC Interrupting Rating tested at rated voltage with unity power factor. DC Interrupting Rating tested at rated voltage with time constant < 0.8 msec.
2. Nominal Resistance measured with < 10% rated current.
3. Nominal Melting I²t measured at 1 msec opening time.
4. Nominal Voltage Drop measured at rated current after temperature has stabilized.

Devices designed to carry rated current for 4 hours minimum. It is recommended that devices be operated continuously at no more than 80% rated current. See "Temperature Derating Curve" for additional derating information.

Devices designed to be mounted with marking code facing up.

Temperature Derating Curve

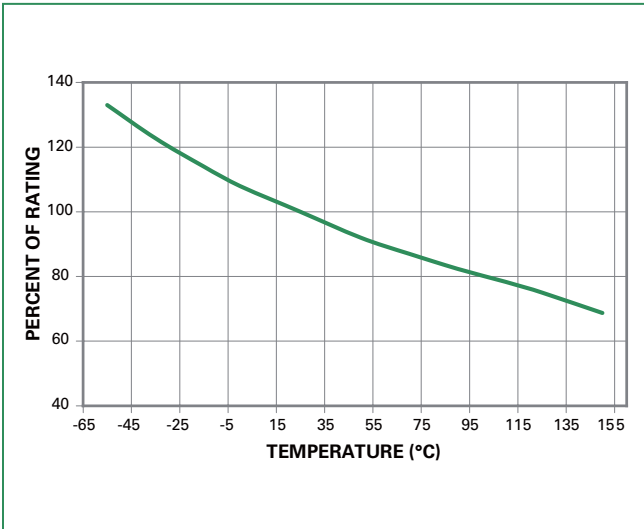

Note:

1. Derating depicted in this curve is in addition to the standard derating of 20% for continuous operation.

Example:

For continuous operation at 75 degrees celsius, the fuse should be derated as follows:

$$I = (0.80)(0.85)I_{RAT} = (0.68)I_{RAT}$$

Average Time Current Curves

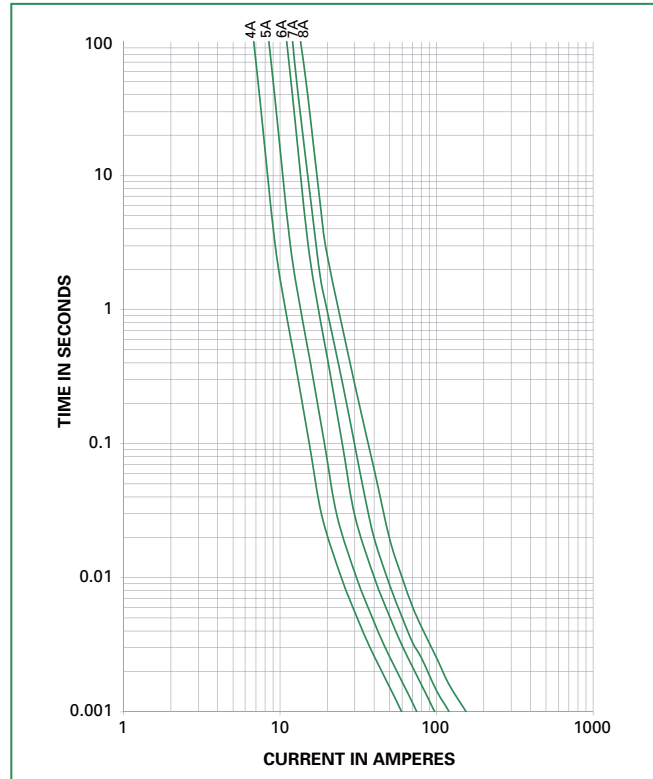

Soldering Parameters

Reflow Condition	Pb – free assembly	
Pre Heat	- Temperature Min ($T_{s(min)}$)	150°C
	- Temperature Max ($T_{s(max)}$)	200°C
	- Time (Min to Max) (t_s)	60 – 180 seconds
Average Ramp-up Rate (Liquidus Temp (T_L) to peak)	3°C/second max.	
$T_{s(max)}$ to T_L - Ramp-up Rate	5°C/second max.	
Reflow	- Temperature (T_L) (Liquidus)	217°C
	- Temperature (t_L)	60 – 150 seconds
Peak Temperature (T_p)	260 ^{+0/-5} °C	
Time within 5°C of actual peak Temperature (t_p)	10 – 30 seconds	
Ramp-down Rate	6°C/second max.	
Time 25°C to peak Temperature (T_p)	8 minutes max.	
Do not exceed	260°C	

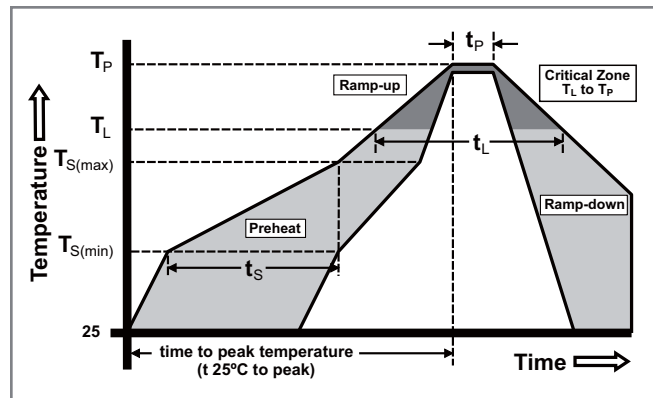

Wave Soldering

260°C, 10 seconds max.

Product Characteristics

Materials	Body: Advanced Ceramic Terminations: Ag / Ni / Sn (100% Lead-free) Element Cover Coating: Lead-free Glass
Moisture Sensitivity Level	IPC/JEDEC J-STD-020C, Level 1
Solderability	IPC/EIC/JEDEC J-STD-002B, Condition B
Humidity Test	MIL-STD-202, Method 103B, Conditions D
ESD Immunity	IEC 61000-4-2, 8kV Direct
Resistance to Solder Heat	MIL-STD-202, Method 210F, Condition B

Moisture Resistance	MIL-STD-202, Method 106G
Thermal Shock	MIL-STD-202, Method 107G, Condition B
Mechanical Shock	MIL-STD-202, Method 213B, Condition A
Vibration	MIL-STD-202, Method 201A
Vibration, High Frequency	MIL-STD-202, Method 204D, Condition D
Dissolution of Metallization	IPC/EIC/JEDEC J-STD-002B, Condition D
Terminal Strength	IEC 60127-4

Dimensions

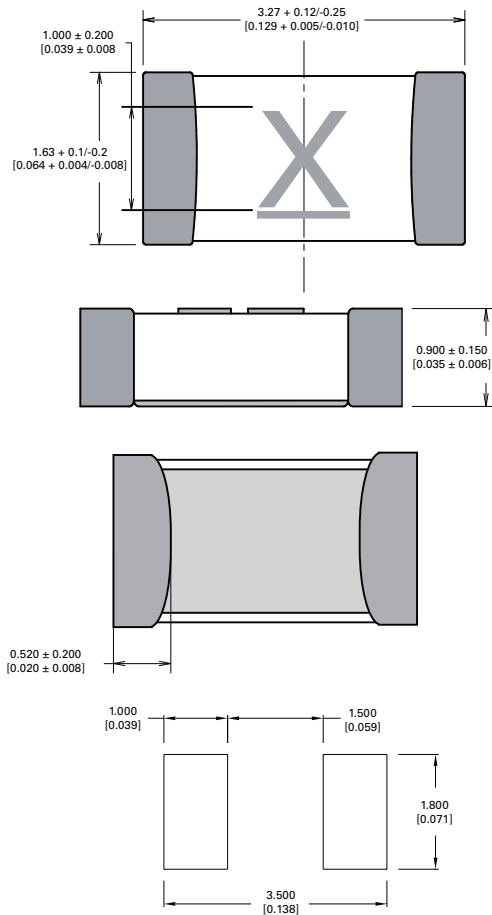

Part Marking System

Amp Code	Marking Code
001.	<u>H</u>
1.25	<u>J</u>
01.5	<u>K</u>
002.	<u>N</u>
02.5	<u>O</u>
003.	<u>P</u>
03.5	<u>R</u>
004.	<u>S</u>
005.	<u>T</u>
006.	<u>U</u>
007.	<u>W</u>
008.	<u>X</u>

Part Numbering System

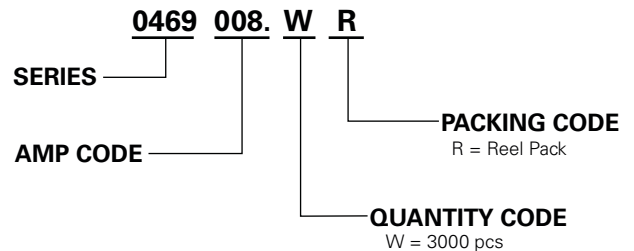

Packaging

Packaging Option	Packaging Specification	Quantity	Quantity & Packaging Code
8mm Tape and Reel	EIA-481-1 (IEC 286, part 3)	3000	WR

www.DataSheet4U.com